



OMNI210



Operator's Manual

LINLONG LIMITED
www.weldpro.com

**THANK
YOU**

**for your
purchase!**



Take a moment and subscribe to our youtube channel. Weldpro is committed to releasing lots of tutorial and how-to videos to help you fine tune your welding skill.



Dear Valued customer,

We at Weldpro would like to thank you very much for being our valued customer. We take great pride in providing quality welding equipment at an affordable price.

As an experienced welder, your feedback (no matter positive or negative) will be an important factor for us to improve the quality of our product and our customer service. We would greatly appreciate if you would take a moment to provide feedback for the product that you purchased.

Weldpro is always there to assist you should you have any questions.

Sincerely, your friends at Weldpro!



Linlong Limited

1307 West Valley Highway North, Suite 103, Auburn, Washington 98001
www.weldpro.com Tel:253-329-2179

Technical support: 651 329 2686

Email: support@weldpro.com

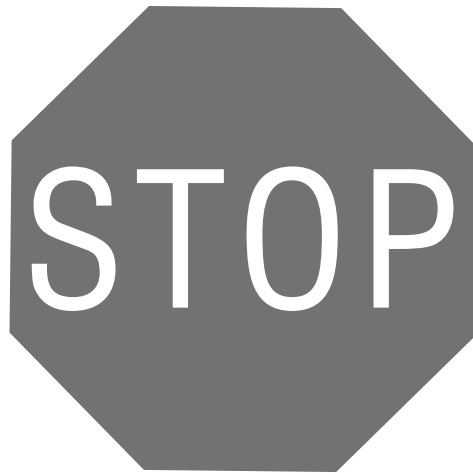

IMPORTANT

**For any questions, concerns, or
problems contact Weldpro**



**Support directly at
651-329-2686**

Introduction

This manual contains the description of the hardware and the operating instructions of the equipment. For your safety and that of others, please read this manual carefully.

Attention

Pay attention to the words following the signs below.

Sign	Description
 DANGER	The word following this sign means that there is great potential danger, which may cause a major accident, damage or even death, if the instructions are not followed.
 WARNING	The word following this sign means that there is some potential danger, which may cause bodily injury or property damage, if the instructions are not followed.
 ATTENTION	The word following this sign means that there is potential risk, which may cause malfunctions and/or breakdowns, if the instructions are not followed.

Edition

The contents of this manual are updated regularly in order to include all product updates. The manual is to be used solely as a user's guide, except where indicated otherwise. No warranties of any kind, whether expressed or implied are made in relation to the information, descriptions, suggestions or any other content of the manual.

The images of this manual are for reference only. If there is any inconsistency between the image and the actual product, the actual product will govern.

CONTENTS

1 WELDPRO SAFETY	5
2 PRODUCT DESCRIPTION	18
3 THREE YEARS WARRANTY	19
4 TECHNICAL PARAMETERS	20
5 INSTRUCTIONS FOR THE INSTALLATION	21
6 PANEL FUNCTION ILLUSTRATION	30
7 OPERATION PARAMETER RECOMMENDATION	38
8 CIRCUIT DIAGRAM	41
9 ATTENTIONS & PREVENTIVE MEASURES	42
10 POTENTIAL OPERATING PROBLEMS	43
11 DAILY MAINTENANCE	44
12 INITIAL PROBLEM DIAGNOSIS	45
13 DAILY CHECKING	47

For Arc
Welding
and Cutting
like a
Weldpro

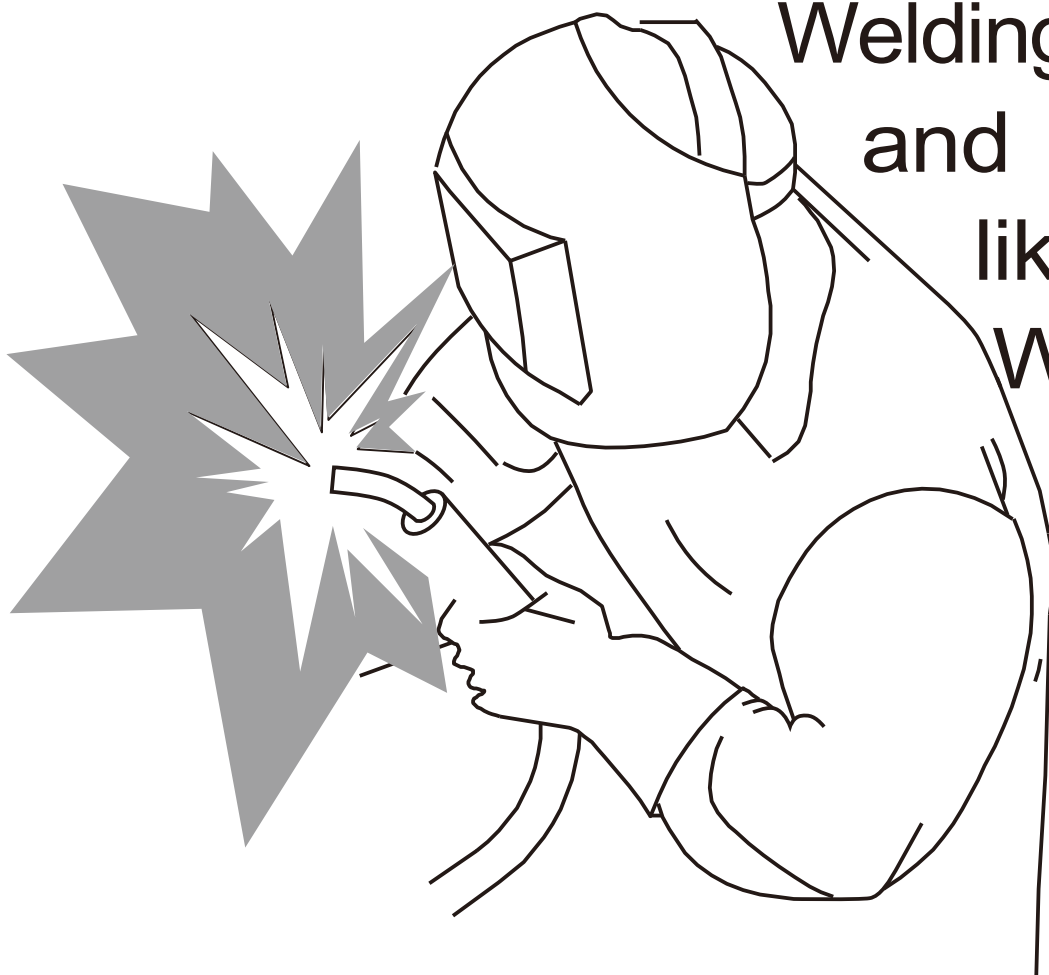

Thank you for using Weldpro arc welding and cutting equipment.

We ask you to work like a weld-pro and weld-pros weld and cut safely. Please read and comply with the sample safety procedures outlined in this guide and the equipment Owner's Manual.



Always read and follow the Owner's Manual, the safety labels on the product, and all applicable safety standards, especially ANSI Z49.1, Safety in Welding, Cutting, (we recommend you get a copy and keep it handy).



Only qualified persons should install, operate, maintain, and repair this equipment. A qualified person is defined as one who, by possession of a recognized degree, certificate, or professional standing, or who by extensive knowledge, training and experience, has successfully demonstrated the ability to solve or resolve problems relating to the subject matter, the work, or the project and has received safety training to recognize and avoid the hazards involved.

Thank you for working safely.

1 General Safe Practices.....	7
2 Arc Welding Hazards.....	7-9
3 Plasma Arc Cutting Hazards.....	10-12
4 Special Situations & Equipment.....	13-14
5 EMF Information.....	14-15
6 California Proposition 65 Warnings.....	15
7 Principal Safety Standards.....	15
8 Lens Shade Selector Guide.....	16
9 Weld Cable Selector Guide.....	17

1. General Safe Practices

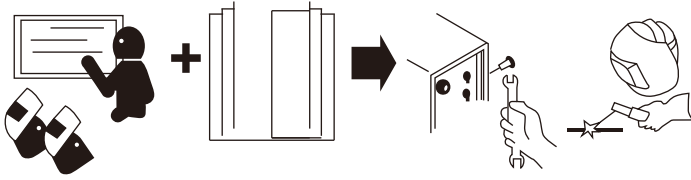

Become trained and read the instructions before working on the machine or welding or cutting. Read and understand the Safety Data Sheets (SDSs) and the manufacturer's instructions for adhesives, coatings, cleaners, consumables, coolants, degreasers, fluxes, and metals.

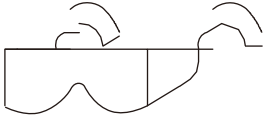

Wear approved safety glasses with side shields under your welding helmet or face shield and at all times in the work area.

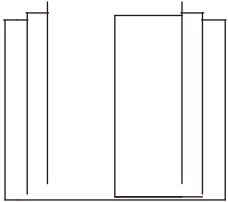

Read and follow all labels and the Owner's Manual carefully before installing, operating, or servicing unit. Read the safety information at the beginning of the manual and in each section.

Wear a safety harness if working above floor level. Keep children away from all equipment and processes.

Do not install or place machine on or over combustible surfaces.

Use GFCI protection when operating auxiliary equipment in damp or wet locations.

Use only genuine replacement parts from the manufacturer.

Perform installation, maintenance, and service according to the Owner's Manuals, industry standards, and national, state, and local codes.

2. Arc Welding Hazards



Electric shock from welding electrode or wiring can kill.

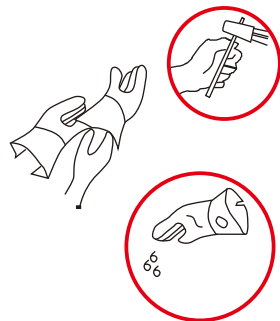

Wear dry, hole-free insulating gloves and body protection. Do not touch electrode with bare hand. Do not wear wet or damaged gloves.

Do not touch live electrical parts.

Do not use AC weld output in damp, wet, or confined spaces, or if there is a danger of falling.

Use AC output ONLY if required for the welding process.

If AC output is required, use remote output control if present on unit. Do not use worn, damaged, undersized, or repaired cables.

Additional safety precautions are required when any of the following electrically hazardous conditions are present: in damp locations or while wearing wet clothing; on metal structures such as floors, gratings, or scaffolds; when in cramped positions such as sitting, kneeling, or lying; or when there is a high risk of unavoidable or accidental contact with the workpiece or ground. For these conditions, use the following equipment in order presented: 1) a semiautomatic DC constant voltage (wire) welder, 2) a DC manual (stick) welder, or 3) an AC welder with reduced open-circuit voltage.

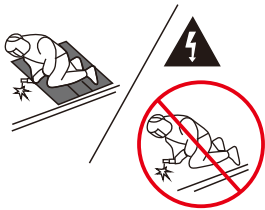

Protect yourself from electric shock by insulating yourself from work and ground. Use non-flammable, dry insulating material if possible, or use dry rubber mats, dry wood or plywood, or other dry insulating material big enough to cover your full area of contact with the work or ground and watch for fire.

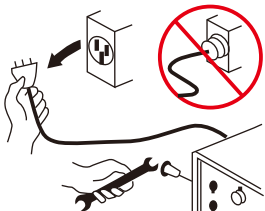

Disconnect input plug or power before working on machine. Do not make input connections if color blind.

Frequently inspect input power cord and ground conductor for damage or bare wiring – replace immediately if damaged – bare wiring can kill. Keep cords dry, free of oil and grease, and protected from hot metal and sparks. Be sure input ground wire is properly connected to a ground terminal in disconnect box or receptacle.

Properly install, ground, and operate all equipment according to its Owner's Manual and national, state, and local codes.



Breathing welding fumes can be hazardous to your health.



Keep your head out of the fumes. Do not breathe the fumes. Use enough ventilation, exhaust at the arc, or both, to keep fumes and gases from your breathing zone and the general area. The recommended way to determine adequate ventilation is to sample for the composition and quantity of fumes and gases to which personnel are exposed.

Read and understand the Safety Data Sheets (SDSs) and the manufacturer's instructions for adhesives, coatings, cleaners, consumables, coolants, degreasers, fluxes, and metals.

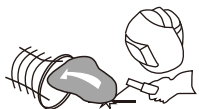

Use enough forced ventilation or local exhaust (forced suction) at the arc to remove the fumes from your breathing area.



Use a ventilating fan to remove fumes from the breathing zone and welding area. If adequacy of ventilation or exhaust is uncertain, have your exposure measured and compared to the Threshold Limit Values (TLV) in the Safety Data Sheet (SDS).

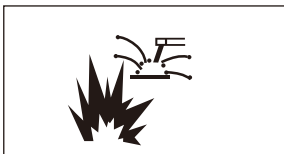

Welding can cause fire or explosion.

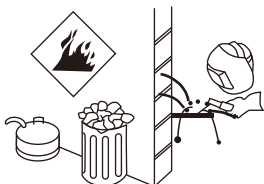

Do not weld near flammable material or where the atmosphere can contain flammable dust, gas, or liquid vapors (such as gasoline). Move flammables at least 35 feet (11 meters) away or protect them with flame-proof covers (see NFPA 51B listed in Section.

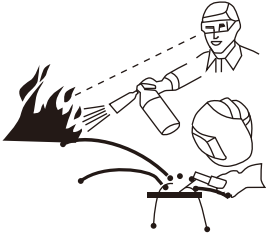

Welding sparks can cause fires. Have a fire extinguisher nearby and have a trained fire watcher ready to use it. After completion of work, inspect area to ensure it is free of sparks, glowing embers, and flames.



Do not weld on containers that have held combustibles, or on closed containers such as tanks, drums, or pipes unless they are properly prepared according to AWS F4.1 and AWS A6.0 (see Safety Standards in Section 9).



Welding can cause fire or explosion.

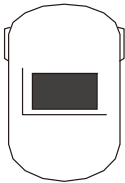

Use welding helmet with correct shade of filter (see Section to choose the correct shade).



Wear welders cap and safety glasses with side shields. Use ear protection when welding out of position or in confined spaces. Button shirt collar.

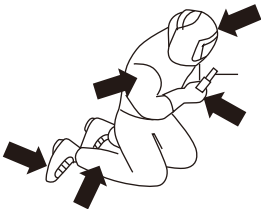

Wear body protection made from durable, flame-resistant material (leather, heavy cotton, wool). Body protection includes oil-free clothing such as leather gloves, heavy shirt, cuffless trousers, high shoes, and a cap.



Moving parts can injure.

Keep hands, hair, loose clothing, and tools away from moving parts such as fans, belts, wire drive rolls, and rotors. Keep all doors, panels, and guards closed and secured.

3. Plasma Arc Cutting Hazards

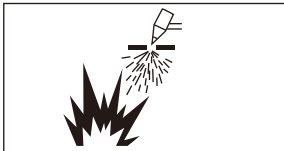

Cutting sparks can cause fire or explosion.



Do not cut near flammable material or where the atmosphere can contain flammable dust, gas, or liquid vapors (such as gasoline). Move flammables at least 35 feet (11 meters) away or protect them with flame-proof covers (see NFPA 51B listed in Section 9).

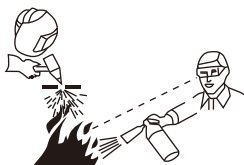

Cutting sparks can cause fires. Have a fire extinguisher nearby, and have a trained fire watch ready to use it. After completion of work, inspect area to ensure it is free of sparks, glowing embers, and flames.



Do not cut on containers that have held combustibles, or on closed containers such as tanks, drums, or pipes unless they are properly prepared according to AWS F4.1 and AWS A6.0 (see Safety Standards in Section 9).

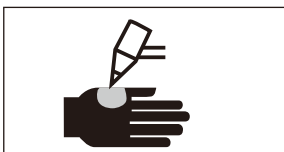

Plasma arc can injure.

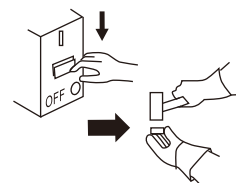

Turn off power before disassembling torch.

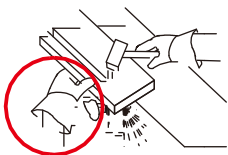

Do not grip material near cutting path.
Do not touch hot parts bare-handed.



Electric shock from torch or wiring can kill.



Wear dry insulating gloves. Do not wear wet or damaged gloves. Do not touch live electrical parts.
Do not use worn, damaged, undersized, or repaired cables.

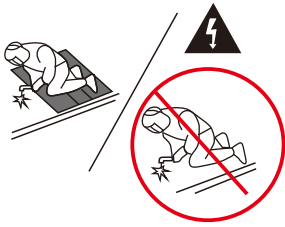

Protect yourself from electric shock by insulating yourself from work and ground. Use non-flammable, dry insulating material if possible, or use dry rubber mats, dry wood or plywood, or other dry insulating material big enough to cover your full area of contact with the work or ground. Watch for fire, smoke, and sparks.

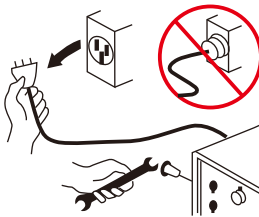

Disconnect input plug or power before working on machine. Do not make input connections if color blind.

Frequently inspect input power cord and ground conductor for damage or bare wiring – replace immediately if damaged – bare wiring can kill. Keep cords dry, free of oil and grease, and protected from hot metal and sparks. Be sure input ground wire is properly connected to a ground terminal in disconnect box or receptacle.

Properly install, ground, and operate this equipment according to its Owner's Manual and national, state, and local codes.



Breathing cutting fumes can be hazardous to your health.



Keep your head out of the fumes. Do not breathe the fumes. Use enough ventilation, exhaust at the arc, or both, to keep fumes and gases from your breathing zone and the general area. The recommended way to determine adequate ventilation is to sample for the composition and quantity of fumes and gases to which personnel are exposed.

Read and understand the Safety Data Sheets (SDSs) and the manufacturer's instructions for adhesives, coatings, cleaners, consumables, coolants, degreasers, fluxes, and metals.

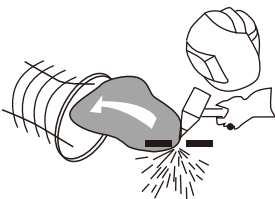

Use enough forced ventilation or local exhaust (forced suction) at the arc to remove the fumes from your breathing area.

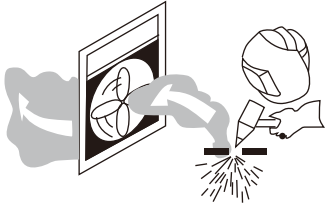

Use a ventilating fan to remove fumes from the breathing zone and cutting area. If adequacy of ventilation or exhaust is uncertain, have your exposure measured and compared to the Threshold Limit Values (TLV) in the Safety Data Sheet (SDS).

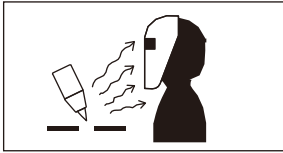

Arc rays can burn eyes and skin.

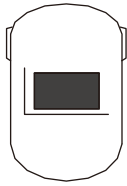

Use welding helmet or face shield with correct shade of filter (see Section to choose the correct shade).



Wear welders cap and safety glasses with side shields. Use ear protection when cutting out of position or in confined spaces. Button shirt collar.

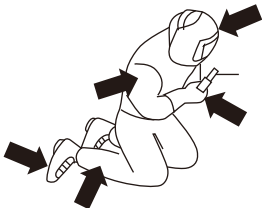

Wear body protection made from durable, flame-resistant material (leather, heavy cotton, wool). Body protection includes oil-free clothing such as leather gloves, heavy shirt, cuffless trousers, high shoes, and a cap.

Periodically double-check all nuts and bolts for tightness and condition

Loose or incorrect hardware and fasteners can injure, and damage equipment.

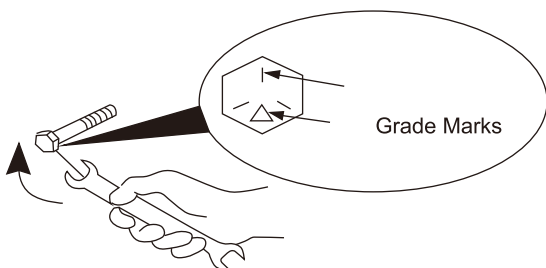

If necessary, always replace any fastener with one of equal size, grade, and type. Be sure the grade marks on replacement fastener match the original bolt. The manufacturer's identification mark .

4. Special Situations & Equipment



Confined spaces can be hazardous.

Confined spaces are areas which lack room for full movement and often lack ventilation, such as storage tanks, vats, tunnels, boilers, pipes, hold of a ship, corners of a room, near a ceiling or floor corner, or in a pit. Gases can collect and form dangerous concentrations.

Always open all covers, remove any hazardous or toxic materials, provide forced ventilation, and provide a means to turn off power and gas from the inside.

Never work alone — have constant communication with someone outside who can quickly turn off power and gas, is trained in rescue procedures, and is able to pull you out in case of emergency.

Do not use AC weld output in confined spaces.

Insulate yourself from work and ground using non-flammable, dry insulating material if possible, or use dry rubber mats, dry wood or plywood, or other dry insulating material big enough to cover your full area of contact with the work or ground, and watch for fire.

Always check and monitor the air quality in the space. Welding or cutting fumes and gases can displace air and lower the oxygen level — use ventilation and, if needed, an air-supplied respirator. Be sure the breathing air is safe. The recommended way to determine adequate ventilation is to sample for the composition and quantity of fumes and gases.

Always remember: All normal arc welding and cutting hazards are amplified in confined spaces. See ANSI Z49.1 listed in Principal Safety Standards (Section 9).



Cylinders can explode if damaged.

Confined spaces are areas which lack room for full movement and often lack ventilation, such as storage tanks, vats, tunnels, boilers, pipes, hold of a ship, corners of a room, near a ceiling or floor corner, or in a pit. Gases can collect and form dangerous concentrations.

Always open all covers, remove any hazardous or toxic materials, provide forced ventilation, and provide a means to turn off power and gas from the inside.

Never work alone — have constant communication with someone outside who can quickly turn off power and gas, is trained in rescue procedures, and is able to pull you out in case of emergency.

Do not use AC weld output in confined spaces.

Insulate yourself from work and ground using non-flammable, dry insulating material if possible, or use dry rubber mats, dry wood or plywood, or other dry insulating material big enough to cover your full area of contact with the work or ground, and watch for fire.

Always check and monitor the air quality in the space. Welding or cutting fumes and gases can displace air and lower the oxygen level — use ventilation and, if needed, an air-supplied respirator. Be sure the breathing air is safe. The recommended way to determine adequate ventilation is to sample for the composition and quantity of fumes and gases.

Always remember: All normal arc welding and cutting hazards are amplified in confined spaces. See ANSI Z49.1 listed in Principal Safety Standards (Section 9).

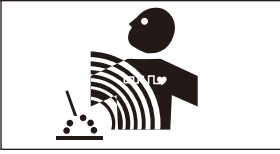

Electric and magnetic fields (EMF) can affect Implanted Medical

Wearers of Pacemakers and other Implanted Medical Devices should keep away. Implanted Medical Device wearers should consult their doctor and the device manufacturer before going near arc welding, spot welding, gouging, plasma arc cutting, or induction heating operations.



Hot parts can burn.

Do not touch hot welded or cut parts with bare hand. If handling is needed, use proper tools and/or wear heavy, insulated welding gloves to prevent burns. Allow cooling period before handling parts or working on equipment.



Falling equipment can injure, and damage equipment.

Use lifting eye to lift unit only, NOT running gear, gas cylinders, trailer, or any other accessories. Use correct procedures and equipment of adequate capacity to lift and support unit. If using lift forks to move unit, be sure forks are long enough to extend beyond opposite side of unit. Do not place unit where it can easily tip over or fall.

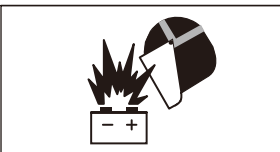

Battery charging output and battery explosion can injure.

Sparks can cause battery gases to explode. Do not smoke and keep matches and flames away from battery. Wear a face shield or safety glasses when working near or on a battery. Do not use welder or plasma cutter to charge batteries or jump start vehicles unless the unit has a battery charging feature designed for this purpose.

5. EMF Information

Electric current flowing through any conductor causes localized electric and magnetic fields (EMF). The current from arc welding (and allied processes including spot welding, gouging, plasma arc cutting, and induction heating operations) creates an EMF field around the welding circuit. EMF fields can interfere with some medical implants, e.g. pacemakers. Protective

measures for persons wearing medical implants have to be taken. For example, restrict access for passers-by or conduct individual risk assessment for welders. All welders should use the following procedures in order to minimize exposure to EMF fields from the welding circuit:

1. Keep cables close together by twisting or taping them or using a cable cover.
2. Do not place your body between welding cables. Arrange cables to one side and away from the operator.
3. Do not coil or drape cables around your body.
4. Keep head and trunk as far away from the equipment in the welding circuit as possible.
5. Connect work clamp to workpiece as close to the weld as possible.
6. Do not work next to, sit or lean on the welding power source.
7. Do not weld whilst carrying the welding power source or wire feeder.

About Implanted Medical Devices:

Implanted Medical Device wearers should consult their doctor and the device manufacturer before performing or going near arc welding, spot welding, gouging, plasma arc cutting, or induction heating operations. If cleared by your doctor, then following the above procedures is recommended.

6. California Proposition 65 Warnings



WARNING: The machine is mainly used for industrial purpose. It will cause radio interference indoor, operators shall take fully preventative measures.

For more information, go to www.P65Warnings.ca.gov.



WARNING: Cancer and Reproductive Harm – www.P65Warnings.ca.gov.

For Diesel Engines:



WARNING: Breathing diesel engine exhaust exposes you to chemicals known to the state of California to cause cancer and birth defects or other reproductive harm.

- Always start and operate the engine in a well-ventilated area.
- If in an enclosed area, vent the exhaust to the outside.
- Do not modify or tamper with the exhaust system.
- Do not idle the engine except as necessary.

For more information, go to www.P65Warnings.ca.gov.

7. Principal Safety Standards

Safety in Welding, Cutting, and Allied Processes, American Welding Society standard ANSI Standard Z49.1. Website: www.aws.org.

Safe Practices for the Preparation of Containers and Piping for Welding and Cutting, American Welding Society Standard AWS F4.1 from Global Engineering Documents.

Website: www.global.ihs.com.

Safe Practices for Welding and Cutting Containers that have Held Combustibles, American Welding Society Standard AWS A6.0 from Global Engineering Documents.

Website: www.global.ihs.com.

National Electrical Code, NFPA Standard 70 from National Fire Protection Association. Website: www.nfpa.org and www.sparky.org.

Safe Handling of Compressed Gases in Cylinders, CGA Pamphlet P-1, from Compressed Gas Association. Website: www.cganet.com

8. Lens Shade Selector Guide

Operation/Process	Electrode Size in. (mm)	Arc Current (Amperes)	Minimum Protective Shade	Suggested* Shade No. (Comfort)
Shielded metal arc welding (SMAW)	Less than 3/32 (2.5)	Less than 60	7	—
	3/32–5/32 (2.5–4)	60–160	8	10
	5/32–1/4 (4–6.4)	160–250	10	12
	More than 1/4 (6.4)	250–550	11	14
Gas metal arc welding (GMAW) and flux cored arc welding (FCAW)		Less than 60	7	—
		60–160	10	11
		160–250	10	12
		250–550	10	14
Gas tungsten arc welding (GTAW)		Less than 50	8	10
		50–150	8	12
		150–500	10	14
Air carbon arc cutting (CAC–A)	(Light)	Less than 500	10	12
	(Heavy)	500–1000	11	14
Plasma arc welding (PAW)		Less than 20	6	6 to 8
		20–100	8	10
		100–400	10	12
		400–800	11	14
Plasma arc cutting (PAC)		Less than 20	4	4
		20–40	5	5
		40–60	6	6
		60–80	8	8
		80–300	8	9
		300–400	9	12
		400–800	10	14
Torch brazing (TB)		—	—	3 or 4
Torch soldering (TS)		—	—	2
Carbon arc welding (CAW)		—	—	14
	Plate thickness			
	in.	Mm		
Oxyfuel gas welding (OFW)	Light	Under 1/8	Under 3.2	4 or 5
	Medium	1/8 to 1/2	3.2 to 12.7	5 or 6
	Heavy	Over 1/2	Over 12.7	6 or 8
Oxygen Cutting (OC)	Light	Under 1	Under 25	3 or 4
	Medium	1 to 6	25 to 150	4 or 5
	Heavy	Over 6	Over 150	5 or 6

As a rule of thumb, start with a shade that is too dark to see the weld or cut zone. Then go to a lighter shade which gives sufficient view of the weld or cut zone without going below the minimum. In oxyfuel gas welding, cutting, or brazing where the torch produces a high yellow light, it is desirable to use a filter lens that absorbs the yellow or sodium line in the visible light of the (spectrum) operation.

Guide adapted from ANSI Z49.1, 2012.

9. Weld Cable Selector Guide



 Turn Off power before connecting to weld output terminals.

 Do not use worn, damaged, under- sized, or repaired cables.

NOTICE : The Total Cable Length in Weld Circuit (see table below) is the combined length of both weld cables. For example, if the power source is 100 ft (30 m) from the workpiece, the total cable length in the weld circuit is 200 ft (2 cables x 100 ft). Use the 200 ft (60 m) column to determine cable size.

Welding Amperes	Weld Cable Size** And Total Cable (Copper) Length In Weld Circuit Not Exceeding			
	100 ft (30 m) Or Less		150 ft / (45 m)	200 ft / (60 m)
	10 – 60% Duty Cycle AWG (mm2)	60 – 100% Duty Cycle AWG (mm2)	10 – 100% Duty Cycle AWG (mm2)	
100	4 (20)	4 (20)	4 (20)	3 (30)
150	3 (30)	3 (30)	2 (35)	1 (50)
200	3 (30)	2 (35)	1 (50)	1/0 (60)
250	2 (35)	1 (50)	1/0 (60)	2/0 (70)
300	1 (50)	1/0 (60)	2/0 (70)	3/0 (95)
350	1/0 (60)	2/0 (70)	3/0 (95)	4/0 (120)
400	1/0 (60)	2/0 (70)	3/0 (95)	4/0 (120)
500	2/0 (70)	3/0 (95)	4/0(120)	2x2/0 (2x70)
600	3/0 (95)	4/0 (120)	2x2/0 (2x70)	2x3/0 (2x95)
700	4/0 (120)	2x2/0 (2x70)	2x3/0 (2x95)	2x4/0 (2x120)
800	4/0 (120)	2x2/0 (2x70)	2x3/0 (2x95)	2x4/0 (2x120)
900	2x2/0 (2x70)	2x3/0 (2x95)	2x4/0 (2x120)	3x3/0 (3x95)
1000	2x2/0 (2x70)	2x3/0 (2x95)	2x4/0 (2x120)	3x3/0 (3x95)
1250	2x3/0 (2x95)	2x4/0 (2x120)	3x3/0 (3x95)	4x3/0 (4x95)

* This chart is a general guideline and may not suit all applications. If cable overheating occurs (normally you can smell it), use next size larger cable.

** Weld cable size (AWG) is based on either a 4 volt or less drop or a current density of at least 300 circular mils per ampere.

*** For distances longer than those shown in this guide, see AWS Fact Sheet No. 39, Welding Cables, available from the American Welding Society at <http://www.aws.org>.

PRODUCT DESCRIPTION

The welding machine applies the most advanced inversion technology in the world.

The principle of inversion is to transform the power frequency of 50Hz/60Hz into direct current and invert it into high frequency through a high-power IGBT, then the machine performs voltage-drop and commutation with the output high-power D.C power supply via Pulse Width Modulation (PWM). Since the switch power inversion technology is adopted, the weight and volume decrease greatly while the conversion efficiency increase of more than 30%.

In Addition to MIG, the machine has STICK and TIG functions. It adopts a full digital panel display, which uses synergic adjustment of feeding speed and welding voltage as well to regulate the welding parameters easily.

Our CO2 gas shielded welding machine is equipped with a unique electronic reactor circuit, which can precisely control the short-circuiting transfer and mixed transfer resulted in better performance than other machines. Compared with silicon controlled welding machines and tapped welding, our products have the following advantages: stable wire feed rate, portable, energy-saving, electromagnetic noise free. Besides, our products spatter less, easier arc starting, deep welding pool, high duty cycle etc.

This equipment is portable with full function of STICK, TIG having merits of high-efficiency; power-saving etc. It is especially suitable for family usage and the need of different metal or techniques.

Thank you for choosing our products. Please feel free to propose any suggestions to us; we will make efforts to perfect our products and service.



WARNING!

The machine is mainly used for industrial purpose. It will cause radio interference indoor, operators shall take fully preventative measures.

THREE YEARS WARRANTY

WELDPRO Warranty and Return Terms Welders and Plasma Cutters

All Weldpro welders and plasma cutters are covered under the following specific terms of warranty. All welders and plasma cutters are warranted to the original purchaser only, when purchased through an authorized seller of Weldpro products for a period of three (3) years from the date of purchase, to be free of manufacturers defect or failure. Proof of purchase and date of purchase paperwork will be required by Weldpro at the time of the claim.

Extended warranty coverage may be available for Weldpro welders and plasma cutters at an additional cost. Always check with Weldpro.

The Weldpro warranty is limited to defects, malfunctions or failure of the equipment to operate properly based specifically and solely from manufacturer defects. Any malfunctions from improper use, lack of maintenance, incorrect or insufficient source supply power to the units, shipping damage, and similar failures not related to specific manufacturers defect will not be honored.

Weldpro will not be responsible in the event of a product failure, for lost time in operation or use of said product. Rather it will honor solely the product itself only.

Further, the warranty will cover the repair or replacement of the unit in question for the term of the warranty with either a new or a refurbished unit, or in some cases replacement parts of the same model, at the discretion of Weldpro. As a term of the Weldpro warranty, if and when applicable, individual parts are needed, they may be supplied to the customer rather than replacing the entire unit. Situations like this may include, but are not limited to items such as foot pedals, torches, mig wire rollers, feed spools, or any other item Weldpro deems more practical to supply individually.

Weldpro will provide free shipping return of the damaged product due to manufacturers defect for the first 30 days of the warranty term if shipping is within the lower 48 United States. Customers outside this area must check with Weldpro for further shipping instructions. Failures after the initial 30-day period, and due to manufacturers defect, may not enjoy free return shipping.

If it is determined when the product is returned to Weldpro that there is no malfunction, or that the assumed malfunction by the customer was user error, Weldpro may request a shipping fee refund prior to the return of the item to the customer.

Prior to returning any item thought to be malfunctioning or damaged due to manufacturers defect, customers are required to contact Weldpro first, to explain the failure and to obtain a Return Merchandise Authorization number, or the item may not be covered under the terms of this warranty.

Weldpro ships in the USA from third party shippers such as, but not limited to UPS, FedEx, and the USPS. Weldpro is not responsible for damage that occurs during shipping. It is the customer's responsibility to check the item at the time of delivery. If a customer receives an item damaged, they must immediately contact both Weldpro and the shipper to document and report the damage as soon as possible, and in no circumstances later than 48 hours after delivery. All shipping and delivery dates are tracked for arrival. Weldpro may require photo image of the damage at their discretion.

Returned items within the first 30 days. Undamaged items in good working condition may be returned within the first 30 days of purchase. In such a case, these items are not eligible for the free return shipping policy associated with items that have manufacturers defects. A restocking fee will be charged for said return of up to 25% on any item returned with a valid RMA number that are undamaged and not covered or subject under the terms of this warranty. The amount of the restocking fee is solely at the discretion of Weldpro and based on the condition of the returned item and its accessory parts and packaging. Further, should Weldpro receive an item in good working condition that has sustained physical damage, Weldpro has the right to refuse acceptance of said returned item completely, and the customer will be responsible for return shipping of the product to them.

Weldpro does not imply or suggest any interpretation of the above warranty beyond what is stated in this print of its terms.

Weldpro is not responsible for injury due to improper use of the equipment or failure to heed all of the safety precautions associated with the dangers of welding or cutting metals.

The terms and conditions of the Weldpro warranty are subject to change without notice. Be sure to check the terms of the Weldpro warranty prior to your purchase.

TECHNICAL PARAMETERS

Model Parameters	OMNI210	
Supply voltage (V)	1 phase 230V±15%	1 phase 115V±15%
Frequency (Hz)	50/60	
Rated input current (A)	39(MIG) 31.4(TIG) 43.3(MMA)	41.6(MIG) 34(TIG) 48.8(MMA)
No-load voltage (V)	65	
Output current (A)	40-200(MIG) 5-200(TIG) 20-200(MMA)	40-120(MIG) 5-120(TIG) 20-120(MMA)
Output voltage (V)	16-24(MIG) 10.2-18(TIG) 20.8-28(MMA)	16-20(MIG) 10.2-14.8(TIG) 20.8-24.8(MMA)
Duty cycle (%)	30@200A	
Power factor	≥0.73	
Efficiency (%)	≥80	
Wire speed (ft/min)	39-590	39-315
Post flow (s)	MIG:1±0.5S TIG:0-30S	
Wire diameter (in)	MIG: .023/.030/.035/.040 Flux-cored: .030/.035/.045	
Tungsten diameter (in)	1/16"-3/32"	
Electrode diameter (in)	1/16"-5/32"	
Suitable thickness	>22Ga	
Housing protection class	IP21	
Insulation class	F	
Cooling method	Fan-cooled	
Weight (lb)	50.5	
Dimensions (in)	21.1x10.4x18.4	

INSTRUCTIONS FOR THE INSTALLATION

The welding equipment is equipped with a power voltage compensation device. It keeps the machine working normally when power voltage fluctuates $\pm 15\%$ of the rated voltage.

When using long cable, in order to reduce voltage drop, big section cable is suggested. If the cable is too long, it will affect the performance of the arc and other system functions, it is suggested to use the recommended length.

- 1) Make sure the intake of the machine is not covered or blocked to avoid the malfunction of the cooling system.
- 2) Use ground cable whose section is no less than 6mm^2 to connect the housing and earth. The method is to connect the grounded interface in the back to the earth device, or make sure the earth end of the power interface has been reliably and independently grounded. Both ways can be used together for better security.

OMNI210 Installation procedures:

1. Correct Installation of MIG

- 1) Connect the gas cylinder with CO2 flow meter tightly to the CO2 inlet behind the machine.
- 2) Insert ground cable into socket at the front panel.
- 3) Set the wire wheel with wire on arbor, the wheel hole should be matched with the spool retainer.
- 4) Choose contact tip and rolls according to wire size.
- 5) Loosen the screw of top roll wheel, put the wire into slot via wire-lead tube, adjust the wire-pressing wheel to keep wire fix from gliding, but strength should be suitable in case the wire distorts and affects wire sending.
- 6) Wire roll should turn clockwise rotation to let out wire, to prevent wire from gliding; wire is usually set to the fixed hole on the wheel side. To prevent any bent sections of wire from getting stuck, please cut off this part.
- 7) Insert and tighten the torch on the output socket and feed the wire into the torch by hand.

2. Correct Installation of TIG

- 1) Connect the shielded-gas source correctly. The gas supplying route shall include gas cylinder, argon decompression flow meter and gas pipe. The connecting parts of the gas pipe should be fastened by hose clamp or other objects, in order to prevent leakage and air-in.
- 2) Connect the plug of the TIG torch to the front panel, and fasten it clockwise.
- 3) Connect the plug of the TIG torch to the relative interfaces of the panel and fasten the screw.
- 4) Connect one end of the earth clamp cable to the front panel, and fasten it clockwise, the other end clamp the workpiece.

3. Correct Installation of STICK

- 1) Make sure the cable with the electrode holder and DINSE plug is securely connected. Connect the quick plug to the socket “-” of the machine, and fasten it clockwise tightly.
- 2) Connect the quick plug at one end of the cable into the socket “+” of the machine, and fasten it clockwise, the other end clamps the workpiece.
- 3) Please pay attention to the connecting terminal, DC welding machine has two connecting ways: positive connection and negative connection. Positive connection: holder connects with “-” terminal, while workpiece with the “+” terminal. Negative connection: workpiece with the “-” terminal, holder with the “+” terminal. Choose a suitable way according to the working situation. If an unsuitable choice is made, it will cause an unstable arc, and more spatter. If such problems occur, please change the polarity of the DINSE connectors. It should adopt negative connection when welding with alkaline electrode, while positive connection when welding with acid electrode.

This procedure shall be operated by an authorized electrician!

Connect proper power cable to the distribution box with corresponding capacity according to the input voltage and current (See technical parameter table). Do not connect to the inappropriate voltage and make sure that the difference of power supply is within permitted range.

OMINI210 Set-Up Procedures MIG AND FLUX CORE WELDING

1) Correct procedure for MIG welding and Flux Core welding:

MIG Welding and Flux Core welding share many similarities. The most obvious is that of course they are both “wire feed” methods of welding. Also fairly obvious is that shielding gas is required for MIG welding while none is required for flux core welding since the shielding is accomplished by the powdered flux inside the core of the welding wire. Normal MIG welding is done while connected to reverse polarity, electrode (torch) positive and ground / work clamp negative, also known as DCEP. Flux Core welding, on the other hand is normally done using straight polarity, electrode (torch) negative and ground / work clamp is positive. Also known as DCEN. The Weldpro MIG welders have a very convenient way of changing polarities. Unlike many MIG welders that require you to physically unbolt connections and change them, the Weldpro MIG welders simply allow you to place the small dongle (extension wire on the front of the machine) into either the plus (+) or minus (-) dinse receptacle. Doing either physically connects your welding torch to the polarity that you choose by doing so. The remaining open dinse connector is used for your ground / work clamp.

2) When setting up your machine and installing your reel of welding wire there are a few generic and common practices that you have to follow. First and very important is to be aware that your roll of welding wire is under a certain amount of tension and you must guard against it unraveling while you are in the process of installing it.

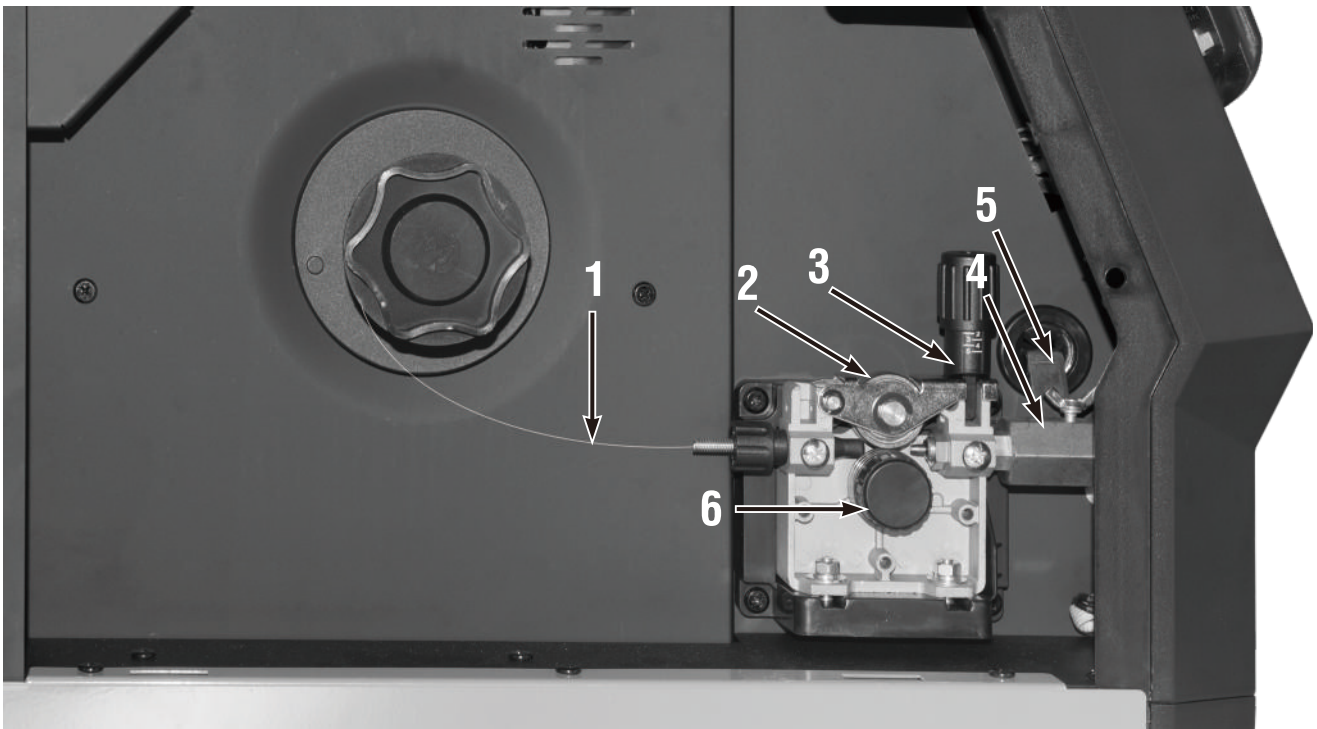

In the above photo, let's go over the components one by one. Number 1 illustrates where the welding wire enters the drive mechanism. Take note that the wire is coming off the wire reel from the bottom, which enables the wire to enter from a direct straight line. Number 2 is the idler roller, which is on a hinge and can be opened by pulling the tension lever (#3) down toward you. Number 4 is the housing that accepts your welding torch cable. There are a few things to be aware of regarding the installation of your welding torch cable. First there are two rubber “O” rings. Prior to inserting the cable, moisten slightly the “O” rings. Simply touch your finger to your tongue and moisten those “O” rings. Do not use any oils or chemicals. Next and very important before you insert the torch cable, be aware of the thumb screw (#5) You must back this screw out so as to prevent it from hitting the cable end and the “O” rings as you insert the cable. Failure to do so can result in the “O” rings tearing or the cable being prevented from completely inserting which will also result in your shielding gas being unable to reach your torch nozzle. Once you have backed out the thumb screw, firmly insert the torch cable into its housing (#4) Once it is

completely seated, you can gently snug down on the thumb screw which will prevent the cable from pulling out of the housing (#4) Number (6) is the black plastic drive roller retaining nut. Based on the size and type wire you will be welding with will determine which drive roller you should install on this drive. To access the rollers, simply unscrew the drive retaining nut (6) and install the correct roller. Common wire sizes are .023, .030, or .035 measured in thousandths. The metric equivalent would be 0.6, 0.8 or 0.9 mm respectively.

Number (7) is simply the larger size arbor used with 10lb spools of welding wire and can be removed when using the smaller 2lb. Spools.

Weldpro supplies a starter set of drive rollers. Simply match the wire size to the number on the drive roller and insert the correct size. One note to be aware of. If you look closely at the grooves in the drive rollers, you will notice both a smooth "V" groove type roller as well as a knurled or toothed style drive roller. The smooth style is designed for solid MIG wire which is used with C25 gas, while the knurled style drive roller is designed to be used with Flux Core type welding wire. Flux Core wire is much more delicate because of its hollow nature which holds the powdered flux core. As such it is very important to impart only a light tension from your (#3) tension adjuster knob. Over tightening can result in "egg shaping" of the welding wire which may cause it to bind in the MIG liner or contact tip.

The following photo illustrates the break down of the torch end of the mig cable. After a brief explanation of the components below, we will go over the installation of the MIG wire and feeding process through the entire MIG cable.

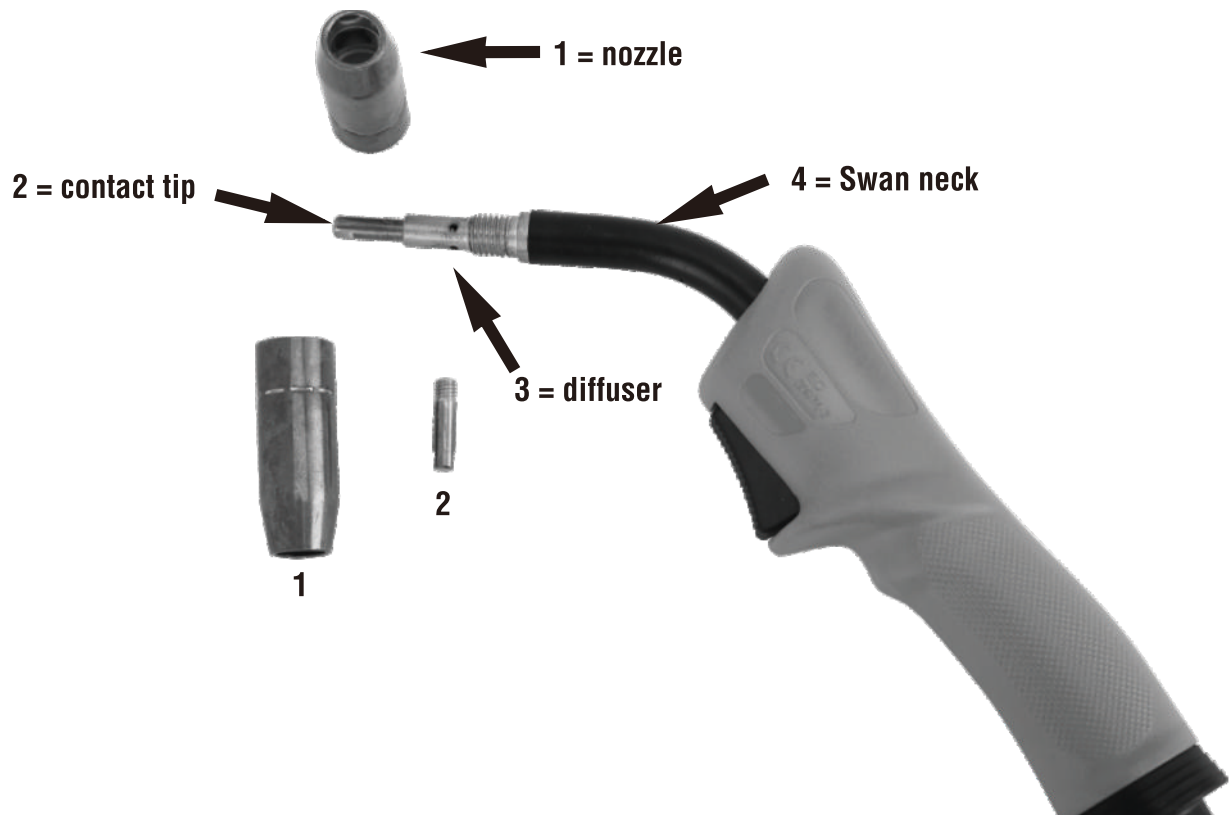

In the photo of the MIG torch gun there are just a few important things to know. First is (#1) the torch nozzle. The torch nozzle is designed to direct the flow of the MIG shielding gas so as to protect the weld area. As such, this nozzle is not even entirely necessary while using Flux Core wire welding and in situations where either clearance or vision is obstructed it can be removed and set aside. IMPORTANT = This torch nozzle IS NOT THREADED ON to the torch head. It is simply a friction fit. While holding your torch in one hand, a slight turn in the clockwise direction as you view the nozzle, while pulling will easily remove

the nozzle. Likewise, a slight turn once again in the clockwise direction while gently pushing on the nozzle will replace it. Trying to unthread in a counter clockwise direction and forcing it off will risk damage to the torch head and diffuser. Number (2) is the contact tip. A few things to be very aware of regarding this component. The contact tip is numbered to match the size of the welding wire you are going to use. As such must be matched to that size wire. To remove the contact tip a MIG pliers is recommended to avoid damage to the tip, but the removal is simply unthreading it in a counter clockwise fashion. Replacing the contact tip (2) is just the opposite. The contact tip only requires gentle snugging. Remember these components are brass and over tightening will damage the soft material. Number (3) is the diffuser. The diffuser is also considered a consumable, however it will not be necessary to replace it anywhere as often as contact tips. One very important thing to know about removing and replacing the diffuser (3) is that it is LEFT HAND THREAD. Clockwise will loosen the diffuser and counter clockwise will tighten it. (Just the opposite of normal threads) In case you are wondering about this, one reason is that under normal use and buildup of weld material on the contact tip, designing these threads with opposite thread will prevent the diffuser from coming loose when periodically replacing contact tips. Should the need arise to change the diffuser, you will notice a small plastic ring at the end of the Swan Neck (#4) pull back that ring against the rubber of the swan neck ever so slightly will expose two flats on the diffuser. This will provide access with an open end (spanner) wrench to gently, and remembering LEFT HAND THREAD, to remove and replace the diffuser if needed.

Initial Installation of Welding Wire

The process is very straight forward and should present no issues. While this can be intimidating for first time users, it really is rather simple provided a few necessary steps are followed. As mentioned above, prepare the torch cable as explained. being aware to moisten the “O” rings and back out the thumb screw. Firmly push the torch cable into its housing. Next, open the tensioner knob (#3) in the first photo and open the idle roller assembly. Next remove the black plastic retaining nut which holds the drive roller. Check the drive roller designation to be sure you have proper size as well as style. Replace the drive roller to match the welding wire you are about to install and gently snug the black plastic drive roller retaining nut.

There are multiple ways to actually install the welding wire itself, but one way that you may find easier is to first prepare the welding wire arbor size depending on the reel size so it is ready to accept your wire. Then, while holding your welding wire securely on the reel to prevent unraveling, expose 6 to 8 inches or so of wire. Feed that wire into the leading conduit going into your drive housing, over your drive roller and into your torch at least 6 inches into the torch. Then close your idler pully hinge, and snap over the tensioner adjuster (3) being sure it's not too tight. At this point you can install your wire reel onto the arbor and snug it with the included nut so that there is a slight drag on the reel of wire just enough to prevent it from unraveling. A note here ... for first time users, you may find it helpful to snip off a 12” length or so of your welding wire initially, and before you install the wire from the reel, through the drive roller assembly, simply run the separate piece of wire through the drive mechanism. This will allow you to pre-set the tension on the drive roller tensioner so you know it will not be too tight to close. This can be helpful while you have your hands full with the reel of wire that would like nothing more than to unravel all over your shop! Hope that helps a bit.

Next you must prepare your torch cable by being sure it is stretched out as straight as possible before feeding the welding wire all through the cable. Be sure there are no kinks or bends in the cable. Next, and very important, remove both the nozzle and the contact tip before feeding your wire. Removing the contact tip will greatly help the wire feed and allow it to come all the way through without catching on the small orifice of the contact tip. This step will allow you also to double check the diameter of the contact tip to be sure it is the correct size to match your welding wire.

Once you have your wire installed, your drive tension adjuster in place, your cable stretched out straight, and your contact tip removed, you are ready to feed your welding wire. Be sure you have also plugged in the chrome trigger plug connector to the front of the welder. Plug your welder in to the electrical receptacle, power it on and allow it to completely boot up. Once it does, be sure your mode selector is set to MIG, and your 2T / 4T is set in the 2T mode as well. Next squeeze the trigger trigger to start feeding the wire through. NOTE the Weldpro welder is equipped with an auto sensor that can recognize high amperage

welding current. When feeding wire you will notice the feed speed will start off slowly, and then when the machine realizes you are not welding, but rather feeding new wire, it will speed it's feed up to maximum feed speed. So don't be alarmed. When the wire has successfully fed through about 6 to 8 inches out of the torch end you can release the trigger and slide your contact tip over the exposed wire, then gently snug it back up on the threads of the diffuser. Install your nozzle as explained previously, snip the excess wire to length (about $\frac{1}{2}$ to $\frac{3}{4}$ beyond the nozzle).

Check your work metal is clean and free of all mill scale, securely connect your work / ground clamp, be sure you have all your safety equipment ready, and your gas is connected and turned on if you are MIG welding. Next we will cover connecting the shielding gas.

Connecting your gas is another straight forward process however being a multi process welder, there are a few things to discuss. First, it is important to know that MIG welding requires a mixed gas, typically called C25 which is 25% carbon dioxide and 75% argon. Straight argon gas is required for TIG welding. The two processes CANNOT share or interchange their respective required gases. BE SURE YOUR WELDING SUPPLY STORE provides you with the correct gas for the correct process. A mistake here by them can cause hours of frustration trying to determine why you cannot achieve a good weld.

With your supply tank valve closed, connect to it your gas regulator supplied with your welder. Remember all these connections are brass and gentle snugging is all that is required. Over tightening will easily strip the threads. Next connect your supplied rubber gas line from your regulator to the back of the Weldpro MIG welder, again just snugging the line. Once you have completed feeding your welding wire through you are ready to introduce the shielding gas. Very gently open the supply gas valve being very careful to introduce it to the regulator slowly. After initially breaking open the valve, open it to its full open position backseating the tank valve to full open. Shielding gas tanks seal from leaking in the fully closed and fully open positions. Opening your gas valve partially can cause unwanted leaking of gas.

Once you have all this accomplished, with your welder plugged in and in MIG mode, pick up your torch end and walk around to your regulator with it. Squeeze the trigger and while your wire feeds set the flow to approximately 9 or 10 LPM or in the case of CFH set 15 to 20. These numbers can be fine tuned to your liking at a later time. Snip off the excess wire, connect your work clamp and with your safety equipment on you are just about ready to start welding. **Remember DCEP for MIG GAS welding, and DCEN for Flux Core welding.**

BEFORE YOU DO ANY WELDING PLEASE GO OVER THE FEATURES AND MACHINE SETTINGS FOR THIS WELDING PROCESS FURTHER ALONG IN THIS MANUAL.

CONNECT SHIELDING GAS

The required Argon gas cylinder should only be connected to the welder through a proper regulator / flowmeter. The working range of the gas flow (depending on the work being done) is approximately 20 cubic feet per hour (CFH) or 9.5 litres per minute (LPM). All press on connection hoses should be further secured with a clamp to prevent inadvertent disconnects. Snug connections to both the regulator, argon tank and welding machine. Over tightening any of these connections can damage the equipment. After connecting your flow regulator to both the argon tank and the back of your TIG welder, your connections are complete. When initially opening the valve on your argon tank, take care to gently crack it open at first so as not to shock the flow regulator. Once argon reaches the flow regulator you can proceed to open the argon tank valve fully.

SHARPEN TUNGSTEN ELECTRODE

Note : WARNING! Some Electrodes may have materials added to them that are hazardous to breathe. Wear a respirator and ANSI-approved Safety goggles when grinding an Electrode.

The tungsten electrode needs to be properly shaped to a point. When doing so it is recommended you use a dedicated grinding wheel. Preferably a diamond coated wheel inexpensive and effective. Also note that while grinding the tungsten to a point, the grinding marks should run longitudinally with the length of the tungsten rather than across the width of the tungsten to avoid arc wander while the arc is finding ground as it welds. The general rule of thumb for sharpening your tungsten is to sharpen it twice to 2 ½ times the diameter of the tungsten you have chosen to use. One technique you may find useful is to place the unshaped tungsten in your cordless drill while sharpening it. That can help produce a more uniform taper.

ASSEMBLE TIG TORCH

The TIG torch consists of the pink in color ceramic end called a “cup”, the white insulator on the torch body, the “collet body” the “collet” the “back cap” (which comes in different lengths) and of course the tungsten. Screw your “collet body” into the front of the TIG torch past the white insulator. Slide your “collet” into the back side of your torch head with the larger end sticking out. From the back side, slide your shaped tungsten into the “collet” and allow it to protrude slightly out the front of the torch. Then install your “back cap” and gently snug it. Screw your “cup” onto the front of your torch until it gently snugs against the white insulator. Tungsten cups all have numbers on them. The numbers designate the diameter of the opening of that “cup” in 1/16ths of an inch. So a number 8 cup for example has a ½ inch opening. As a general rule

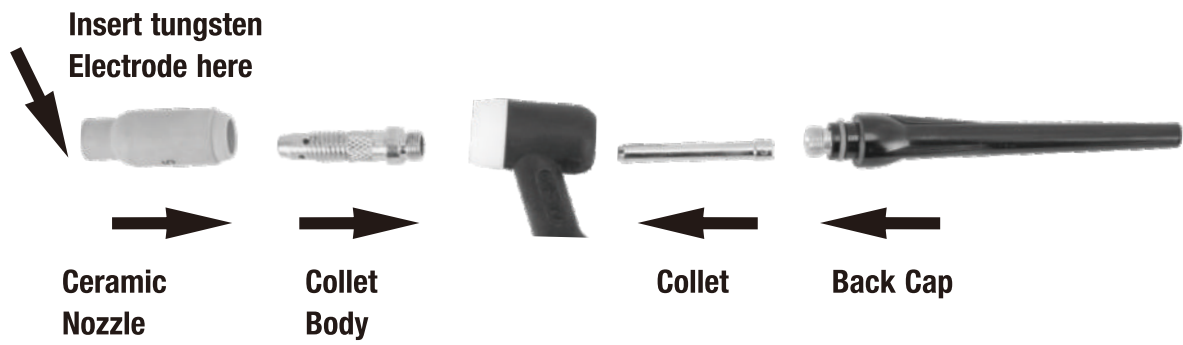

Connecting the electrode and work (also called ground) cables correctly to your welder. Lets take a moment here to clarify what can be a confusing subject to new users. Generically, when welding, the user has a choice of polarity connections. What is correct for one type of welding may be totally wrong for another type of welding.

On the following page we will explain what is happening and which way to connect for which type of welding.

Stick Welding (MMA) Set Up

Your OMNI210 offers a very nice stick welding feature that employs both a Hot Start function as well as an Arc Force function. Be sure to select the proper MMA process on the front panel. Additional options are available. The Hot Start function sends higher initial current to your electrode upon initial arc start which helps start and maintain a good arc. The Arc Force function allows the arc to maintain suitable voltage should your electrode get too close to your work. This helps prevent the electrode from fusing to the work.

While stick welding sometimes can be done using straight polarity, the most common initial set up is reverse polarity. This means your Electrode Holder is connected to the PLUS (+) dinse connector while your work clamp is connected to the MINUS (-) dinse. Of course it is recommended you check with the specific welding rod you are using to determine which welding polarity is right for that rod.

Note : While it is commonly known that most inverter style welders are not well suited for 6010 stick welding rod and are rather recommended to use the more popular and versatile 6011 stick welding rod for applications that require a deep penetrating rod, the OMNI210 machine with its HOT START and ARC FORCE features enjoys much more success with the 6010 style welding electrode rod.

Explanatory drawing for Installation of OMNI210 (MIG):

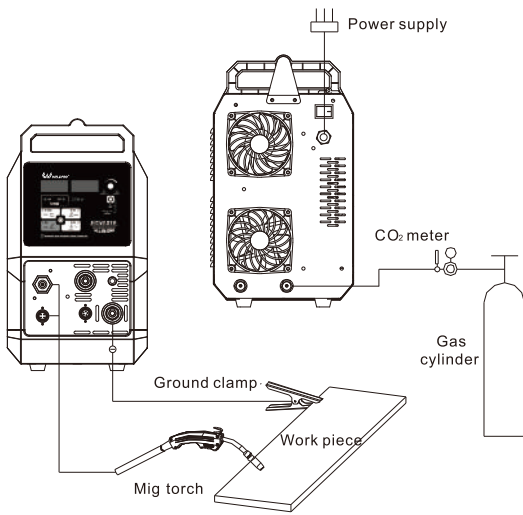

Explanatory drawing for Installation of OMNI210 (TIG):

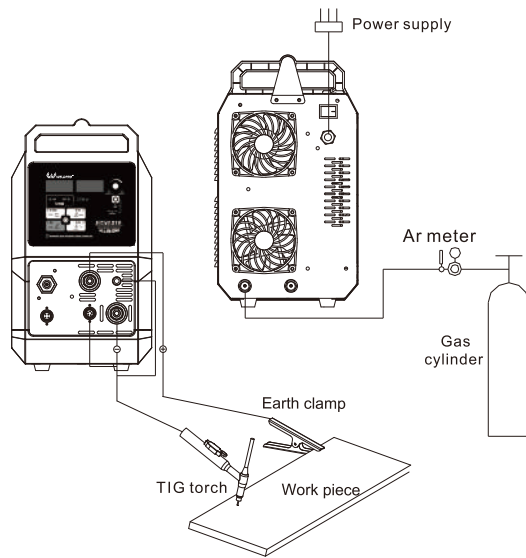

Explanatory drawing for Installation of OMNI210 (STICK):

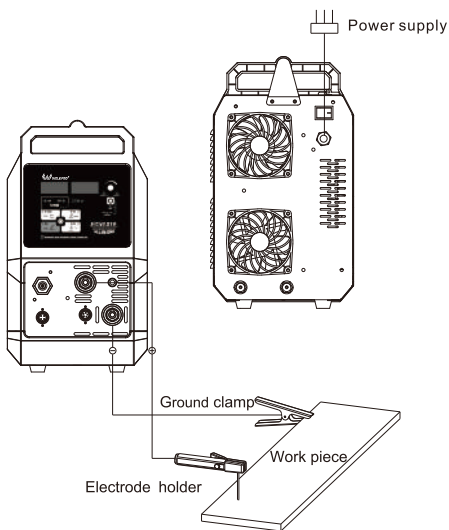

PANEL FUNCTION ILLUSTRATION

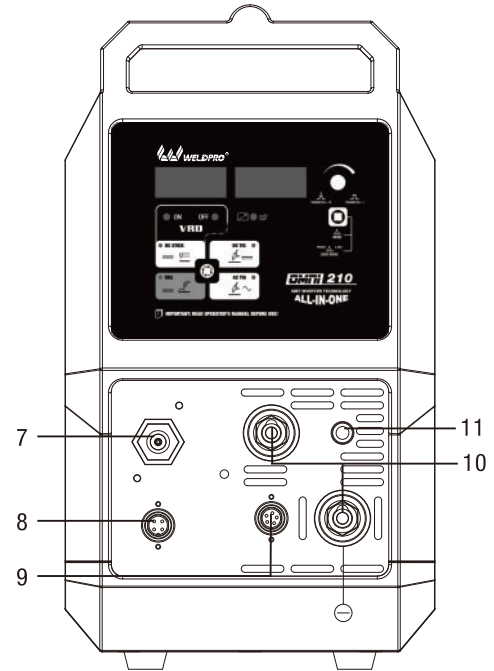
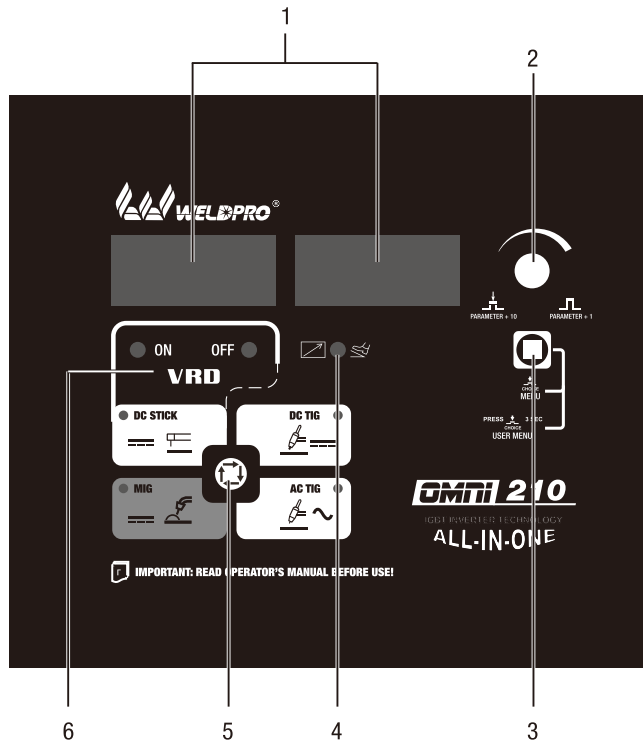

PANEL FUNCTION ILLUSTRATION

Front panel instruction:

1	Multifunctional data display	7	Welding torch socket
2	Parameter adjustment knob	8	Four core socket (MIG)
3	MENU Button	9	Five core socket (TIG)
4	REM indicator	10	Output terminal
5	Function selection Button	11	Quick Connect for Gas
6	VRD indicator		

VRD Indicator

A VRD (voltage reduction device) is designed to reduce electric shock hazards present on the output of a welding power source when operating in STICK mode. Note that the presence of VRD should not be used as a substitute for the use of appropriate safety practices as indicated in section one of this manual.

Both the green and red indicator lights only operate in STICK mode.

The green VRD ON light illuminates (red light is OFF) when the VRD is active. Under this condition the open circuit voltage of the unit is limited to below 24V DC, thus reducing the potential of serious electric shock (such as when changing electrodes).

The red VRD OFF light illuminates (green light is OFF) when the VRD is inactive. Under this condition the output voltage of the unit will be at welding potential which in some cases may exceed 24V DC.

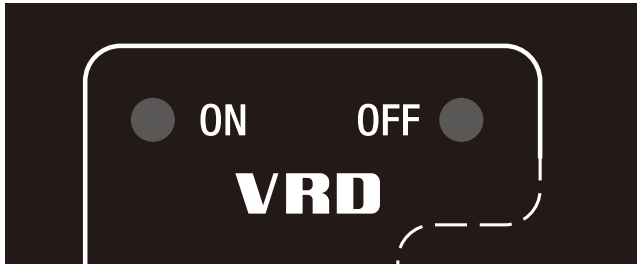

Multifunctional data display

MIG Mode

This digital meter is used to display the pre-set (preview) Wire Feed Speed in Metres Per Minute (MPM) in MIG mode and actual welding amperage of the power source when welding. At times of non-welding, the digital meter will display a pre-set (preview) value of Wire Feed Speed. This value can be adjusted by Parameter adjustment knob.

STICK and TIG Modes

The digital meter is used to display the pre-set (preview) amperage in STICK / TIG modes and actual welding amperage of the power source when welding. At times of non-welding, the amperage meter will display a pre-set (preview) value in both STICK and TIG modes. This value can be adjusted by varying Parameter adjustment Knob. When welding, this digital meter will display actual welding amperage in all modes.

At the completion of welding, the digital meter will hold the last recorded amperage value for a period of approximately 10 seconds in all modes. The amperage meter will hold the value until;

- (1) any of the front panel controls are adjusted in which case the unit will revert to preview mode,
- (2) welding is recommenced, in which case actual welding amperage will be displayed, or
- (3) a period of 10 seconds elapses following the completion of welding in which case the unit will return to preview mode.

Function Selection Button

Press and release this button to change the selected weld process mode from MIG to DC TIG to STICK to AC TIG. The weld process will change to the next process in the sequence each time the button is pressed and released. The red indicators next to the button will illuminate to identify MIG to DC TIG to STICK to AC TIG process mode.

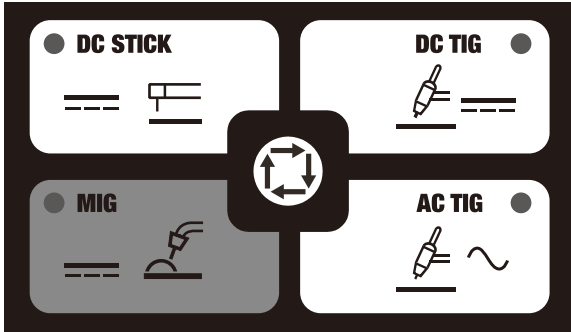

MENU Button

Press and release the MENU Button to enter or exit from the advanced programming mode. To exit, simply press and release the button again. Any changes made are saved. The advanced programming menu items are described in detail for each welding mode in Advanced Features Details.

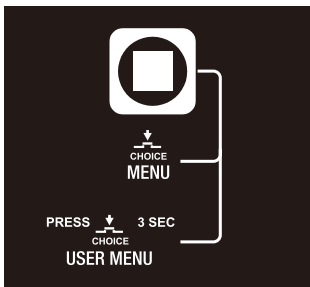

Parameter adjustment knob

The Parameter knob adjusts the amount of welding current delivered by the power source. In STICK and TIG modes, the amperage control knob directly adjusts the power inverter to deliver the desired level of output current. In MIG mode, the knob adjusts the speed of the wire feed motor (which in turn adjusts the output current by varying the amount of MIG wire delivered to the welding arc) and output voltage. The optimum wire speed required is dependent on the type of welding application. The setup chart on the inside of the wire feed compartment door provides a brief summary of the required output settings for a basic range of MIG welding applications. The value may also be adjusted while a weld is in progress – if this occurs, the left display will briefly switch to show the adjusted value as the knob is turned, and will automatically revert back to showing the weld current measurements when the knob is not being turned.

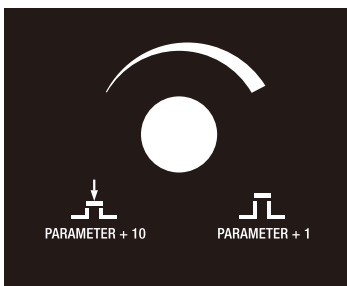

Advanced Features Details

Select the weld process you wish to view Advanced Features for.

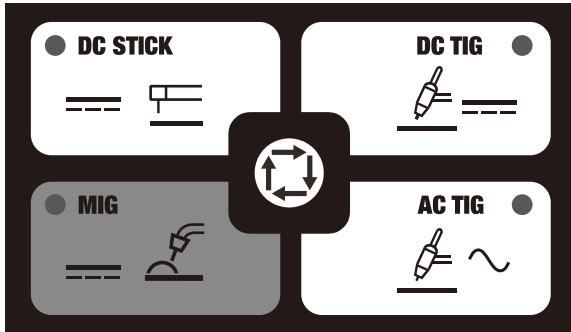

Then press the MENU button for 3S to enter or exit from the Advanced Features programming function of the welder, then press and release the MENU button to move forward through the list.

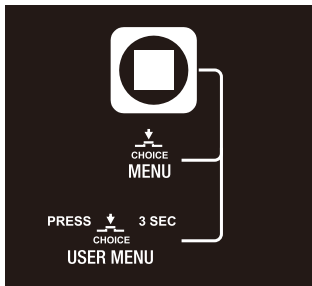

To change the value of that parameter, simply turn the Parameter adjustment knob to change it. If the setting has been changed from its previous value the welder will save the new value when the knob is turned to view the next parameter, or if the user activates a control to cause the welder to exit Advanced Features mode as described earlier. Once the beginning or end of the menu list is reached, additional turning of the left knob in that direction will not result in any change of the displayed parameter.

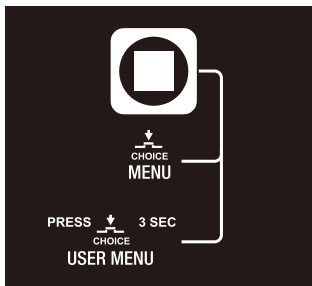

MIG/MAG/FLUX Mode Advanced Features Menu map

Function	Left Display	Right Display (Factory Default Values)	Limits	Comments
MIG Operator Controls	PROC/ESS	C25	C25/C100/ FLUX/ALUM	C25=75%Ar+25%CO2 C100=100%CO2 FLUX=No Gas,Use the cored self-protecting wire. ALUM=100%Ar,Use the aluminum wire. Adjust the parameters by selected Shielding gas.
Wire diameter	WIRE/DIAM	0.030	0.024/0.030/ 0.035	Adjust the parameters by selected wire diameter
Workpiece thickness	MAT	20Ga	20Ga-3/16	Welding parameters can be automatically recommended by adjusting this parameter
Inductance adjustment	INDU	0	-10%-10%	To adjust the intensity of the welding arc
Unit adjustment	WFS/UNIT	IPM	MPM-IPM	MPM:Metric system IPM: Imperial
Restore Factory Defaults	FACT/DFLT	NO	NO - YES	When YES is selected all the user adjustable values in this table (except Arc Hour Accumulated Runtime) are reset to the Factory Default Values.

STICK Mode Advanced Features Menu map

USER MENU

Function	Left Display	Right Display (Factory Default Values)	Limits	Comments
Voltage Reduction Device	VRD	ON	ON - OFF	A VRD is designed to reduce electric shock hazards present on the output of welding power source when operating in STICK mode.
Restore Factory Defaults	FACT/DFLT	NO	NO - YES	When YES is selected all the user adjustable values in this table are reset to the Factory Default Values.

MENU

Function	Left Display	Right Display (Factory Default Values)	Limits	Comments
Hot Start	HOT	OFF	OFF-100%	Hot Start is used to improve the start characteristics for stick electrodes, e.g. low hydrogen electrodes.
ARC force	FORC	OFF	OFF-100%	ARC force Amps sets the force current base the welding current.

DC TIG Modle Advanced Features Menu map

USER MENU

Function	Left Display	Right Display (Factory Default Values)	Limits	Comments
Arc start	STRT	HF	HF-LIFT	You can choose DC TIG arc start. HF: High frequency arc start. LIFT: Scratch arc start, need to through short circuit the workpiece and tungsten then lift the torch to start welding.
Tungsten diameter	TUNG	GENE/RAL	GENE/RAL -0.040	You can choose different tungsten diameter
Up slope	UP/SLOP	0.0	0-15S	After welding starts, the current will slowly rise to the preset current according to the selected time
Down slope	DOWN/SLOP	0.0	0-25S	Down slopestate: After welding starts, the current will slowly drop to 0 according to the selected time
Post flow adjustment	POST	0	0-30S	Post flow time adjustment: After the end of the welding state, the shielding gas will continue to be delivered to the top of the welding gun, until the selected time is reached, the gas delivery will be disconnected
Unit adjustment	WFS/UNIT	IPM	MPM-IPM	MPM: Metric system IPM: Imperial
Restore Factory Defaults	FACT/DFLT	NO	NO - YES	When YES is selected all the user adjustable values in this table are reset to the Factory Default Values.

MENU

Function	Left Display	Right Display (Factory Default Values)	Limits	Comments
Pulse function	PULS	OFF	OFF-PPS	You can choose to turn on the pulse function. The digital display on the left will show PPS
Pulse frequency	PPS	0.5	0.5-200	This value represents how many pulses will be output in 1S
Base current setting	BASE	5%	5-95%	This value will set the pulse base current according to the currently set welding current
Peak current setting	PEAK	5%	5-95%	This value will set the pulse peak current according to the currently set welding current

AC TIG Mode Advanced Features Menu map

USER MENU

Function	Left Display	Right Display (Factory Default Values)	Limits	Comments
Wave setting	WAVE	SQUA	SQUARE-SINE	You can change the welding method of your AC TIG according to the selection of different output waveforms SQUA/SINE
Tungsten diameter	TUNG	GENE/RAL	GENE/RAL -0.040	You can choose different tungsten diameter
Up slope	UP/SLOP	0.0	0-15S	After welding starts, the current will slowly rise to the preset current according to the selected time
Down slope	DOWN/SLOP	0.0	0-25S	Down slopestate: After welding starts, the current will slowly drop to 0 according to the selected time
Post flow time adjustment	POST	0	0-30S	Post flow time adjustment: After the end of the welding state, the shielding gas will continue to be delivered to the top of the welding gun, until the selected time is reached, the gas delivery will be disconnected
Unit adjustment	WFS/UNIT	IPM	MPM-IPM	MPM: Metric system IPM: Imperial
Restore Factory Defaults	FACT/DFLT	NO	NO - YES	When YES is selected all the user adjustable values in this table are reset to the Factory Default Values

MENU

Function	Left Display	Right Display (Factory Default Values)	Limits	Comments
AC Balance	BAL	30%	30%-70%	It can adjust AC Balance, value from 30%-70%
AC frequency	AC.FR	40H	40H-200H	Adjust this parameter to adjust the AC output frequency, the value can be adjusted from 40HZ to 200HZ
Pluse function	PULS	OFF	OFF-PPS	You can choose to turn on the pulse function, when on, the digital display on the left will show PPS
Pulse frequency	PPS	0.5	0.5-200	This value represents how many pulses will be output in 1S
Base current setting	BASE	5%	5-95%	This value will set the pulse base current according to the currently set welding current
Peak current setting	PEAK	5%	5-95%	This value will set the pulse peak current according to the currently set welding current

ERROR CODE

1.Wire feeder fault code

Panel display Err-03 and multifunctional data display keep flashing,it will automatically exit the panel after troubleshooting, the panel will display the reference of the settings before the fault occurs.

2.Over output current fault code

Panel display Err-01 and multifunctional data display keep flashing,machine doesn't work,restart the machine, the panel will display the reference of the settings before the fault occurs.

3.Overheat fault code

Panel display Err-02 and multifunctional data display keep flashing, machine doesn't work, this is over heat protection,when the machine cool down, the panel will display the reference of the settings before the fault occurs

Panel display Err-05 and multifunctional data display keep flashing, machine doesn't work, this is the Temperature sensor damage, when this fault solved will automatically exit the panel, and the panel will display the reference of the settings before the fault occurs.

OPERATION PARAMETER RECOMMENDATION

1. Generally, welding current is adequate to welding electrode according with as following:

Electrode specifications	.098"	.126"	.157"	.197"
Welding current	70-100A	110-140A	170-220A	230-280A

2. Welding variables when use TIG

TIG welding specifications of stainless steel as follows:

Thickness (ga)	Tungsten diameter (in)	Wire diameter (in)	Type of butt joint	Welding current (A)	Gas flow (cfh)
25	0.040	0.040	plain butt joint	35-40	8.4-12.6
21	0.040	0.040	wire filling	35-45	8.4-12.6
19	0.063	0.063		40-70	10.8-16.8
16	0.063	0.063		50-85	10.8-16.8
14	.08-.1	0.78		80-130	16.8-21
11	.098-.12	0.89		120-150	21-25.2

OPERATION PARAMETER RECOMMENDATION

3. Welding variables when use MIG welding

The values listed in the following table are the general specification values under standard condition.

		Plate thickness (ga)	Wire diameter (in)	Interval (in)	Current (A)	Voltage (V)	Welding speed (in/min)	Wire extension (in)	Gas flow rate (cfm)
Square butt welding	Low welding speed	21	.030,.035	0	60~70	16~16.5	19.7~23.6	0.4	0.4
		19	.030,.035	0	75~85	17~17.5	19.7~23.6	0.4	0.4~0.6
		18	.030,.035	0	80~90	16~16.5	19.7~23.6	0.4	0.4~0.6
		15	.030,.035	0	95~105	17~18	17.7~19.7	0.4	0.4~0.6
		14	.040,.047	0~.020	110~120	18~19	17.7~19.7	0.4	0.4~0.6
		13	.040,.047	.020~.040	120~130	19~19.5	17.7~19.7	0.4	0.4~0.6
		10	.040,.047	.040~.047	140~150	20~21	17.7~19.7	0.4~0.6	0.4~0.6
		7	.040,.047	.040~.060	160~180	22~23	17.7~19.7	0.6	0.6
			.047	.047~.063	220~260	24~26	17.7~19.7	0.6	0.6~0.8
			.047	.047~.063	220~260	24~26	17.7~19.7	0.6	0.6~0.8
			.047	.047~.063	300~340	32~34	17.7~19.7	0.6	0.6~0.8
			.047	.047~.063	300~340	32~34	17.7~19.7	0.6	0.6~0.8
	High welding speed	21	.030,.035	0	100	17	51.2	0.4	0.6
		19	.030,.035	0	110	17.5	51.2	0.4	0.6
		18	.030,.035	0	120	18.5	51.2	0.4	0.6
		15	.040,.047	0	180	19.5	51.2	0.4	0.6
		14	.040,.047	0	200	21	39.4	0.6	0.6
		13	.040,.047	0	220	23	47.2	0.6	0.8
		10	.047	0	260	26	47.2	0.6	0.8
		Plate thickness (ga)	Wire diameter (in)	Current (A)	Voltage (V)	Welding speed (in/min)	Wire extension (in)	Gas flow rate (cfm)	
Fillet welding/butt welding	15	.030,.035	60~80	16~17	15.7~19.7	0.4	0.4		
	14	.030,.035	80~100	19~20	15.7~21.7	0.4	0.4~0.6		
	13	.040,.047	120~160	20~22	13.8~17.7	0.4~0.6	0.4~0.6		
	10	.040,.047	150~180	21~23	11.8~15.7	0.4~0.6	0.8~1.0		

		Plate thickness	Wire diameter (in)	Vertical angle of the welding gun	Current (A)	Voltage (V)	Welding speed (in/min)	Wire extension (in)	Gas flow rate (cfm)
Horizontal fillet / butt welding / T joint welding Horizontal fillet / joint welding	Low welding speed	19ga	.030,.035	45°	70~80	17~18	19.7~23.6	0.4	0.4~0.6
		18ga	.035,.040	45°	85~90	18~19	19.7~23.6	0.4	0.4~0.6
		15ga	.040,.047	45°	100~110	19~20	19.7~23.6	0.4	0.4~0.6
		14ga	.040,.047	45°	115~125	19~20	19.7~23.6	0.4	0.4~0.6
		13ga	.040,.047	45°	130~140	20~21	19.7~23.6	0.4	0.4~0.6
		10ga	.040,.047	45°	150~170	21~22	17.7~19.7	0.6	0.6~0.8
		7ga	.040,.047	45°	140~200	22~24	17.7~19.7	0.6	0.6~0.8
		3ga	.047	45°	230~260	24~27	17.7~19.7	0.8	0.6~0.8
		0.35in	.047,.063	50°	270~380	29~35	17.7~19.7	1.0	0.8~1.0
		0.47in	.047,.063	50°	400	32~36	13.8~15.7	1.0	0.8~1.0
	High welding speed	19ga	.030,.035	45°	140	19~20	63	0.4	0.6
		18ga	.035,.040	45°	130~150	19~20	47.2	0.4	0.6
		15ga	.040,.047	45°	180	22~23	47.2	0.4	0.6~0.8
		14ga	.047	45°	210	24	47.2	0.6	0.8
		13ga	.047	45°	230	25	43.3	0.8	1.0
		10ga	.047	45°	270	27	43.3	0.8	1.0
		7ga	.047	50°	290	30	31.5	0.8	1.0
		3ga	.047	50°	310	33	27.6	1.0	1.0
	Low welding speed	21ga	.030,.035	10°	60~70	16~17	15.7~17.7	0.4	0.4~0.6
		18ga	.030,.035	30°	80~90	18~19	17.7~19.7	0.4	0.4~0.6
		15ga	.030,.035	30°	90~100	19~20	17.7~19.7	0.4	0.4~0.6
		13ga	.030,.035	47°	100~130	20~21	17.7~19.7	0.4	0.4~0.6
			.040,.047	47°	120~150	20~21	17.7~19.7	0.4	0.4~0.6
		10ga	.040,.047	47°	150~180	20~22	13.8~17.7	0.4~0.6	0.8~1.0
		7ga	.047	47°	200~250	24~26	17.7~19.7	0.4~0.6	0.8~1.0

CIRCUIT DIAGRAM

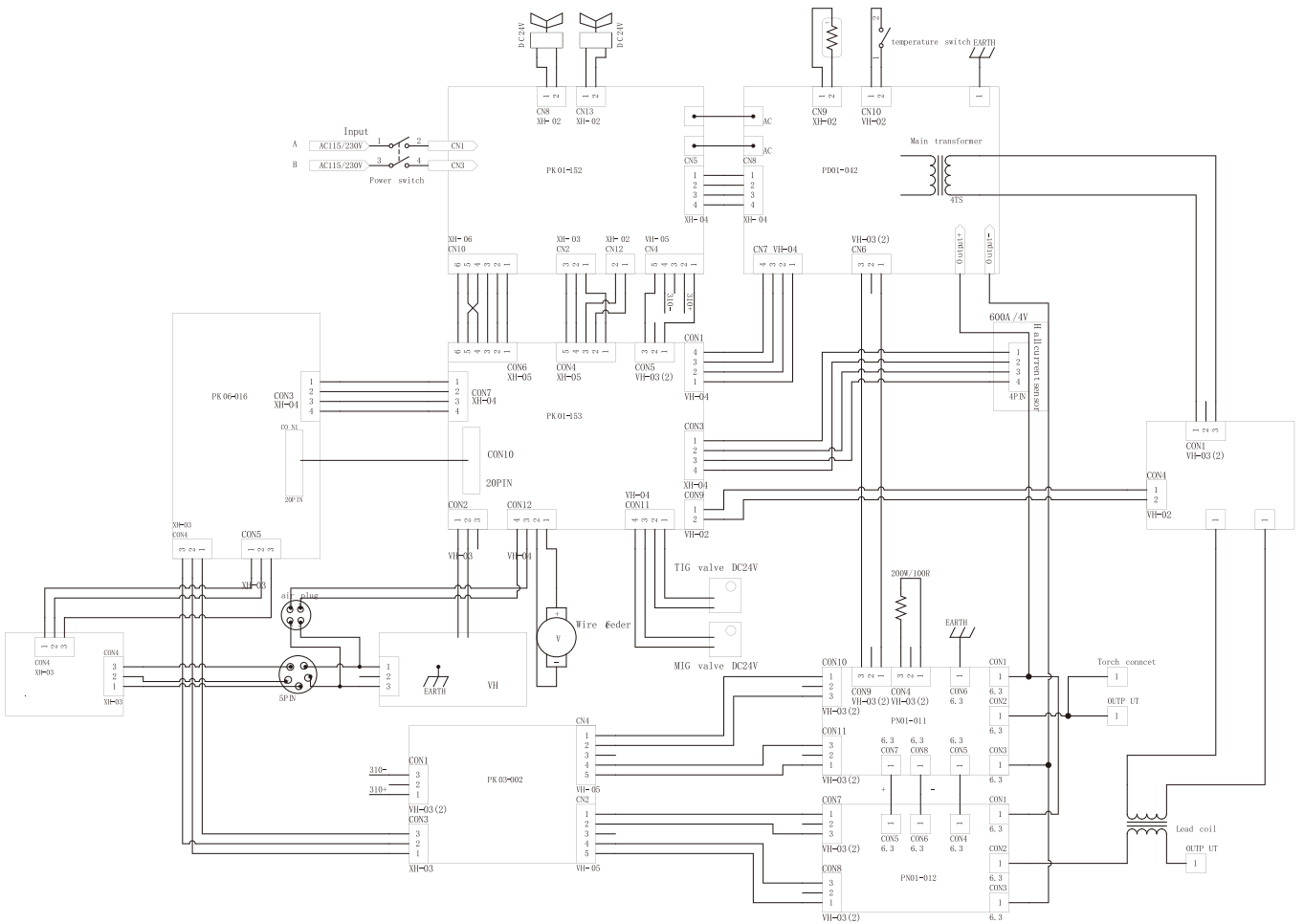

CIRCUIT DIAGRAM

ATTENTIONS & PREVENTIVE MEASURES

1.Environment

1. The machine works in environment where air conditions are dry with a dampness level of max 90%.
2. Ambient temperature should be between -10 to 40 degrees centigrade.
3. Avoid welding with equipment in extreme heat or sun or rain. Avoid water entering the machine.
4. Avoid welding in dust area or the environment with corrosive gas.
5. Avoid gas welding in the environment with strong airflow.

2.Safety Checkpoint

Our welding machine has a protection circuit of over voltage, over current and over heat. When voltage, output current and temperature of machine are exceeding the rated standard, welding machine will stop working automatically. Excessive operation under over voltage, over current or over heat may damage the machine; operator must pay attention to followings.

1) The working area is adequately ventilated!

Each machine has an internal fan to ensure its stable performance. Make sure the intake is not blocked or covered, there should be 0.3 meter distance from welding machine to objects of environment. User should make sure the working area is adequately ventilated. It is important for the performance and the longevity of the machine.

2) Do not over load!

The operator should keep an eye on max duty current (Compared to the selected duty cycle) to make sure that the machine working current does not exceed max duty cycle current. Over-load current will damage and even burn the machine.

If machine exceeds standard duty cycle, it may stop working and switch to protection status. The temperature control switch is activated by over heat released under this circumstance. Meanwhile, the over heat indicator lights up. Under this situation, you do not need to pull out the power plug since the internal fan can work to cool down the machine. When the over heat indicator stops, the temperature has been lowed down to standard range, operator is able to starting working again.

3) Do Not over voltage!

Power voltage can be found in diagram of parameters. Automatic compensation circuit of voltage will assure that welding current keeps is in allowable range. If power voltage is exceeding allowable range limits, it can damage the components of machine. The operator should understand this situation and take preventive measures.

POTENTIAL OPERATING PROBLEMS

The phenomenon listed below may happen due to relevant accessories used, welding material, surroundings and power supply. Please improve surroundings and avoid these problems.

A. Arc starting difficulty. Arc interruption happens easily:

1. Examine whether grounding wire clamp contacts with the work pieces well.
2. Examine whether each joint has improper contact.
3. Be VERY aware of “Hot Rolled” steels mill scale. You may think you have cleaned your work but mill scale is stubborn and will create a bad ground for your work clamp. Aggressively grind away mill scale to clean shiny metal and not merely clean shiny mill scale!

B. The output current fails to reach rated value:

Deviation of input power voltage from rated value may cause the output current to vary with adjusted value. When the power voltage is lower than rated value, the maximum output current may be lower than rated value.

C. The current can not keep stable during operation:

This situation may relate to the following factors:

- 1 The voltage of electric power network changes.
- 2 Serious interference from electric power network or other electric facilities.
- 3 Be sure to check circuit breakers for proper operation.

D. Porosity in welds

- 1 Examine whether the gas supply circuit has leakage.
- 2 Examine whether there are contaminants such as oil, dirt, rust, paint etc. on the surface to be welded.

Remember, Support is available at 1-651-329-2686 Please take advantage of our service should you need to.

DAILY MAINTENANCE



WARNING!

The power shall be cut off completely before all maintenance, repairing works. Make sure to pull out power plug before opening the case.

1. Remove dust regularly with dry compressed air. If the welding machine is used in surroundings with heavy smoke and polluted air, it is necessary to remove dust at least one time one month.
2. The pressure of compressed air can cause damage to small components in the machine.
3. Be sure all electrical connections are clean and secure.
4. Prevent water from entering into the machine and prevent the machine from getting wet. If any, gently blow and dry..
5. If the welding machine is not used for a long time, pack the machine in original package and store in dry surroundings.
6. Periodically check, clean and lubricate drive mechanisms. Check all consumables for need of replacement.

INITIAL PROBLEM DIAGNOSIS

Remember most problems are the result of one or more set up steps needing attention.

For example: tight parts loosen, forgetting to switch on, wrong set up, cable broken and gas rubber pipe cracked, bad circuit breaker, etc. Therefore, please test and inspect these factors. For this reason, an initial diagnosis list for general welding troubles is shown below.

Initial problems diagnose

Area and Item to be Inspected and Maintained		Abnormal Condition								
		No Arc Starting	No gas out	No Wire Feeding	Bad Arc Ignition	Unstable Arc	Dirt on Edge of Weld Seam	Wire Stick to Parent material	Wire Stick to Conductive Tip	Blowhole Formed
Distribution Boxes (Input Protection Devices)	<ol style="list-style-type: none"> 1. Turn on power supply or not? 2. Fuse burnt out. 3. Connection joint loose. 	<input type="radio"/>	<input type="radio"/>	<input type="radio"/>	<input type="radio"/>	<input type="radio"/>	<input type="radio"/>			
Input Cable	<ol style="list-style-type: none"> 1. Examine whether the cable is cut off. 2. Connection joint loose. 3. Over heat. 	<input type="radio"/>			<input type="radio"/>	<input type="radio"/>	<input type="radio"/>			
Welding Power Operation	<ol style="list-style-type: none"> 1. Turn on power supply or not? 2. Phase Lacking. 	<input type="radio"/>	<input type="radio"/>	<input type="radio"/>	<input type="radio"/>	<input type="radio"/>	<input type="radio"/>	<input type="radio"/>	<input type="radio"/>	
Gas Cylinder and Gas Regulator	<ol style="list-style-type: none"> 1. Turn on gas supply. 2. Residual Amount of Gas in the Cylinder. 3. Set value for flow. 4. Connection joint loose. 					<input type="radio"/>				<input type="radio"/>
Gas supply hose (the whole line from the high pressure cylinder to the weld gun)	<ol style="list-style-type: none"> 1. Connection joint loose. 2. Gas hose damaged. 									<input type="radio"/>

INITIAL PROBLEM DIAGNOSIS

Initial problem diagnosis

Area and Item to be Inspected and Maintained		Abnormal Condition								
		No arc	No Gas out	No Wire Feeding	Bad Arc Ignition	Unstable Arc	Dirt on Edge of Weld Sea	Wire Stick to Parent	Wire Stick to Conductive Tip	Blowhole Formed
Wire Feeding Device	<ol style="list-style-type: none"> Wire feeding wheel does not match with the diameter of wire in texturing tube. Dirt on wire feeding wheel, groove blocked Too tight or loose of the tensioner handle Cable liner scored or bent, kinked. 			○	○	○	○		○	
Weld Gun and Cable	<ol style="list-style-type: none"> Wire not feeding smoothly Dirty contact tip, wire feeding liner and cable diameter Worn, blocked up or deformation, etc. 				○	○	○		○	
Body of weld gun	<ol style="list-style-type: none"> Loose connection of conductive tip, nozzle and nozzle contactor. Contact of weld gun body is not plunged in or tightened well . 						○			○
Power supply cable of weld gun as well as cable of switch control	<ol style="list-style-type: none"> Breaker off No power. Bad Ground. 	○	○	○		○		○		
Surface Condition of Parent material and length that wire stretches out	<ol style="list-style-type: none"> Oil, dirty, rust and paint residues. Too long length of wire stretched out. 				○	○	○	○		○
Output Cable	<ol style="list-style-type: none"> Cross-section of cable that connects to parent material is not enough. Loose connection of (+),(-)output cable. Bad electric conductivity of parent material. 				○	○	○			
Lengthened Cable	<ol style="list-style-type: none"> Cross-section of cable is not enough. Poor connection. 				○	○	○	○		
Work Condition for Welding	Welding current, voltage, angle of weld gun, welding rate and wire length stretched out should be confirmed once again gas supply.				○	○	○	○	○	

Contact support if needed at 1-651-329-2686

DAILY CHECKING

WELDING POWER SUPPLY

Position	Check points	Remarks
Control panel	<ol style="list-style-type: none"> 1. Switch condition of operation, transfer and installation. 2. Test the power indicator. 	
Cooling fan	<ol style="list-style-type: none"> 1. Check if there is wind and the sound normal or not. 	Fan design may be on demand.
Power part	<ol style="list-style-type: none"> 1. When electrified, abnormal smell or not. 2. When electrified, abnormal vibration and buzz or not. 3. Color changing and heating or not in appearance. 	
Periphery	<ol style="list-style-type: none"> 1. Gas pipe broken, loosen or not. 2. Housing and other fixed parts loosen or not. 	

WELDING TORCH

Position	Check points	Remarks
Nozzle	If installation fixed, the front distorted.	Reason for air hole
	Contaminated with weld spatter.	Reason for burning the torch (can use spatter-proof material)
Contact Tip	If installation fixed.	Reason of torch screw thread damage.
	Damage of its head and hole blocked or not.	Reason of unstable arc and broken arc.
Wire sending tube inner liner	Check the extended size of the pipe.	Change when less than 6mm, when the extended part too small, the arc will be unstable.
	Wire diameter and the tube inner diameter match or not.	Reason of unstable arc, please use the suitable tube.
	Partial bending and extended.	Reason of poor wires sending and unstable arc, please change.
	Block caused by dirt in the tube, and the remains of the wire plating lay.	Reason of poor wire sending and unstable arc, (use kerosene to wipe or change new one).
	Wire sending tube broken.	tube broken, change new tube.
Gas bypass	Forget to insert or the hole blocked, or different factory component.	May lead to vice (splash) because of poor gas shield, torch body get burned (arc in the torch).

WIRE DRIVE MOTOR

Position	Checking keys	Remarks
Tension arm	Adjust arm to the suitable indicating level do not over tighten.	Lead to unstable arc and wire sending.
Wire lead tube	residue build up in the mouth of the wire tube.	Clean the residue and check the reason and solve it.
	Wire diameter and the tube inner diameter match or not.	If not match, lead to unstable arc and residue.
	Check the tube mouth center is large enough.	If unmatched, it can lead to unstable arc.
Wire wheel	Wire diameter matches the wheel's requirement If the wheel slot blocked.	<ol style="list-style-type: none"> 1. Lead to unstable arc and residue, and block wire tube. 2. Change new one if necessary.
Pressure wheel	Check the stability of its move, and wearing-out of pressed wire, the narrowing of its contact surface.	Lead to unstable arc and wire sending.

CABLE

Position	Checking keys	Remarks
Torch cable	<ol style="list-style-type: none"> 1. If torch cable over bended. 2. If the electrical connection point of plug is loose. 	<ol style="list-style-type: none"> 1. Cause poor wire sending. 2. Unstable arc if cable over bended.
Output cable	<ol style="list-style-type: none"> 1. Wearing-out of the cable insulated material. 2. Cable connecting bare (insulation damage), or loosen (the end of power supply, and cable of main material connecting point). 	<p>For life security and stable welding, adopt suitable method to check according to working place.</p> <ul style="list-style-type: none"> • Simple check daily. • Careful and in-depth check on fixed period.
Input cable	<ol style="list-style-type: none"> 1. If the connection between the plug and the power socket is firm. 2. If the power input end cable fixed. 3. If the input cable is worn out and bares the conductor. 	
Earth cable	If the earth cable that connects the main part is broken and connects tightly.	



LINLONG LIMITED

www.weldpro.com